

Comparison of Actual Results and PVsyst Simulation in the Design of Off-Grid Solar Power Generation System (PLTS) in Karuni Village, Southwest Sumba

Marsul Siregar^{1*}, Cristoni Hasiholan Pardosi², Karel Octavianus Bachri¹, Tajuddin Nur¹, Lanny W. Pandjaitan¹

¹Department of Electrical Engineering, Faculty of Engineering
Atma Jaya Catholic University of Indonesia, Jakarta 12930, Indonesia

²Graduate School of Electrical Engineering, Faculty of Engineering
Atma Jaya Catholic University of Indonesia, Jakarta 12930, Indonesia

Article Info

Article history:

Received
25-03-2024

Accepted
23-04-2024

Keywords:

Actual Production,
Actual and Simulation
Comparison, PVsyst,
PV system (PLTS),
Remote Area,
Renewable Energy

Abstract

This research aims to compare the actual production with the simulations using the PVsyst software for the Off-Grid Solar Power Plant (PLTS) in Karuni Village, Southwest Sumba. The Off-Grid PLTS in Karuni Village is a vital solution for improving remote areas' electricity access. Actual energy production data from the PLTS were obtained from monitoring systems, while simulation results were obtained through PVsyst. The analysis results indicate a difference of approximately 10% between the actual and simulated results. It observed that it is influenced by variability in local weather conditions, maintenance, system management levels, and limitations of the simulation model. The implications of this research emphasize the importance of using accurate data in simulations, improving PLTS system maintenance, and developing more sophisticated simulation models. Recommendations for further research include further analysis of factors influencing the differences in results. This study provides valuable insights into the planning and management of Off-Grid PLTS. It offers perspectives on enhancing the accuracy of future PLTS system planning and management.

Info Artikel

Histori Artikel:

Diterima:
25-03-2024

Disetujui:
23-04-2024

Kata Kunci:

Aktual Produksi,
Energi Terbarukan,
Daerah Terpencil,
Perbandingan aktual
dan simulasi, PLTS,
PVsyst

Abstrak

Penelitian ini bertujuan untuk membandingkan hasil actual produksi dengan simulasi menggunakan software PVsyst pada Pembangkit Listrik Tenaga Surya (PLTS) Off-Grid di Desa Karuni, Sumba Barat Daya. PLTS Off-Grid di Desa Karuni merupakan solusi penting untuk meningkatkan akses listrik di daerah terpencil. Data produksi energi actual PLTS diperoleh dari sistem monitoring, sedangkan hasil simulasi diperoleh melalui PVsyst. Hasil analisis menunjukkan adanya perbedaan kurang lebih 10% antara hasil actual dan simulasi. Hal ini diamati dipengaruhi oleh variabilitas kondisi cuaca lokal, pemeliharaan, tingkat manajemen sistem, dan keterbatasan model simulasi. Implikasi dari penelitian ini menekankan pentingnya penggunaan data yang akurat dalam simulasi, peningkatan pemeliharaan sistem PLTS, dan pengembangan model simulasi yang lebih canggih. Rekomendasi untuk penelitian selanjutnya antara lain analisis lebih lanjut mengenai faktor-faktor yang mempengaruhi perbedaan hasil. Studi ini memberikan wawasan berharga mengenai perencanaan dan pengelolaan PLTS Off-Grid. Hal ini menawarkan perspektif dalam meningkatkan akurasi perencanaan dan pengelolaan sistem PLTS di masa depan mendatang.

1. INTRODUCTION

Electricity is vital in modern life, yet many remote areas in Indonesia, especially in the Eastern regions, still lack adequate access to electricity [1]. The limitations of conventional electricity infrastructure and the distance from the primary power grid make communities in remote villages struggle to access stable and affordable electricity services [2].

*Corresponding author.

Email address: marsul.siregar@atmajaya.ac.id

To address this challenge, both the government and the private sector have launched various programs to improve electricity access in remote areas. One approach taken is to harness renewable energy sources, such as solar energy, to build Off-Grid Solar Power Generation Systems (PLTS) [3], [4]. Off-grid PLTS is considered a promising solution to provide reliable and sustainable electricity access to communities in remote areas.

Despite efforts to improve electricity access in Karuni Village, around 250 family groups still have not received a power supply from PLN. The local government's plans have also not included Karuni Village in the Electricity Supply Business Plan (RUPTL) for 2022-2023.

In response to this, the graduate engineering program of "Magister Teknik Elektro (MTE), under the auspices of the Faculty of Engineering at Atma Jaya Catholic University of Indonesia, has been involved in the development of Off-Grid PLTS in several remote villages. One is Karuni Village in Southwest Sumba Regency, East Nusa Tenggara, Indonesia. With Corporate Social Responsibility (CSR) support from Bank Central Asia (BCA), MEE conducted surveys designed based on needs and allocated funds to build Off-Grid PLTS projects in Karuni Village.

Based on observations from visits to the village, the construction of PLTS is carried out by designing and building facilities to support the operation of electricity in these remote areas. In the planning phase, the system is designed to supply electricity to 32 households, with a total capacity of 6.5 kWp.

This study will compare the simulation results generated by the PVSyst software with actual data from the implemented Off-Grid PLTS system in Karuni Village, Southwest Sumba. Through this comparison, it is hoped that the accuracy of PVSyst simulation in designing and predicting the performance of Off-Grid PLTS systems in real-world environments can be evaluated.

2. LITERATURE REVIEW

2.1 Off-Grid Solar Power Generation System

Off-Grid Solar Power Generation System (Off-Grid PLTS) is an important solution in providing electricity access by conventional power grids in remote or inaccessible areas. This system operates independently and is not connected to the primary power grid. There are several main components in Off-Grid PLTS:

1. Solar Panels: Solar panels, or solar modules, are the main components that convert solar energy into electrical energy. Solar panels are photovoltaic cells that capture solar energy and generate electric current.
2. Energy Storage Batteries: Batteries store the energy generated by solar panels. The stored energy will be used when the sun is not shining, such as at night or during bad weather. Battery capacity is usually measured in kilowatt-hours (kWh).
3. Solar Charger Controller: The battery charging controller regulates the current flow into and out of the battery to prevent overcharging or over-discharging. This controller is essential for extending the battery life and ensuring optimal system performance.
4. Inverter: The inverter converts the direct current (DC) generated by solar panels into alternating current (AC) that household electrical appliances can use. The inverter also regulates the voltage and frequency of electricity to meet user requirements.

Off-Grid PLTS has several advantages, including:

1. Independence in providing electricity without having to rely on conventional power grids.
2. Ability to operate in remote or difficult-to-reach areas without central electricity infrastructure.
3. Use of renewable and environmentally friendly energy sources.

However, Off-Grid PLTS systems face several challenges, such as high initial costs, limited energy storage capacity, and complex maintenance requirements.

2.2 Analysis of PLTS Performance

The performance of a PLTS can be evaluated based on the IEC 61724 standard [5], [6]. This performance analysis aids in evaluating the performance of the PLTS system and gaining a deeper understanding of the efficiency of converting solar energy into electrical energy.

1. Yield Factor

The Yield Factor (Y_F) is a parameter that indicates the ratio between the amount of energy produced in AC form by the installed PLTS array and the number of peak sun hours per kilowatt. The formula is as follows:

$$Y_F = \frac{E_{AC}}{P_{PV}} \quad (1)$$

Where:

Y_F : Yield Factor (kWh/kWp)

E_{AC} : Output of AC energy to the grid (kWh_{AC})

P_{PV} : Installed capacity of PLTS (kW_{pDC})

2. Reference Yield

The Reference Yield (Y_R), also known as peak sun hours, is the result of the total solar radiation absorbed by the surface of the solar panel in kWh/m², divided by the irradiation of the STC array, which has a value of 1000 W/m². The formula is as follows:

$$Y_R = \frac{H_T}{G_{STC}} \quad (2)$$

Where:

Y_R : Reference Yield (kWh/kW)

H_T : Irradiance on the array plane (kWh/m²)

G_{STC} : Reference irradiance STC (1 kW/m²)

3. Performance Ratio

The Performance Ratio (PR) measures the performance of a PLTS system in converting solar energy into electrical energy, represented as a percentage. The formula is as follows:

$$PR = \frac{Y_F}{Y_R} \times 100\% \quad (3)$$

Where:

PR: Performance Ratio (%)

Y_F : Yield Factor (kWh/kWp)

Y_R : Reference Yield (kWh/kW)

4. Capacity Utilization Factor

The Capacity Utilization Factor (CUF) compares the performance of a PLTS system that measures the output of electrical energy that can be generated in each hour during one year. The formula is as follows:

$$CUF = \frac{Y_F}{8760} \times 100\% \quad (4)$$

Where:

CUF: Capacity Utilization Factor (%)

Y_F : Final Yield (kWh/kWp)

2.3 PVSyst Simulation Software

PVSyst is a widely used simulation software in the solar energy industry for planning, analyzing, and modeling solar photovoltaic (PV) systems. This software offers several powerful features to assist in the design and evaluation of PV systems, including:

1. **Solar Radiation Analysis:** PVSyst calculates the solar radiation received by a specific location based on historical weather data. This enables users to predict the amount of solar energy that the PV system can generate during a specific period [7].
2. **Energy Production Calculation:** PVSyst can generate estimates of PV system energy production based on system configuration, including the number of solar panels, orientation, and tilt. This helps users understand system performance and optimize its design [8].
3. **Economic Evaluation:** The software can also perform economic evaluations of PV systems, including calculations of initial investment costs, operational and maintenance costs, and energy savings generated by the system. This helps users make informed decisions about investing in PV systems.
4. **System Design Optimization:** PVSyst allows users to optimize PV system designs by exploring various system configurations and assessing their impact on performance and economics.

The simulation method PVSyst uses is based on complex mathematical models, which consider various factors such as site geometry, weather conditions, component efficiencies, and other technical characteristics of the PV system. The simulation results generated by PVSyst can provide valuable information for the planning and developing of PV systems. With a deep understanding of PVSyst's features and capabilities, users can effectively use this software to design and analyze efficient and economical PV systems.

3. METHODOLOGY

This research employs an experimental quantitative approach to compare the actual and simulated results of Off-Grid Solar Power Generation Systems (PLTS) in Karuni Village, Sumba. The experimental quantitative method is designed to collect empirical data that can be measured numerically and test specific hypotheses through variable control.

The experimental research design comprises a control group (actual results) and a treatment group (simulation results). The control group consists of the installed and operational Off-Grid PLTS in Karuni Village, while the treatment group consists of the simulation results generated by the PVSyst software.

The primary focus of the research variables is the energy production of PLTS, measured in kilowatt-hours (kWh). Other observed variables include energy availability, system efficiency, battery performance, and other parameters relevant to PLTS performance.

The research procedure involves preparation, simulation, actual measurement, and data analysis. Research instruments include the PVSyst software for PLTS simulation, tools for measuring PLTS energy production, and technical documents related to the installed PLTS system in Karuni Village.

Data analysis compares the actual and simulated results of Off-Grid PLTS in Karuni Village. The differences between the two datasets are evaluated using inferential statistics to determine the significance of differences and the accuracy of the simulation.

4. RESULT AND DISCUSSION

4.1 Characteristics of PLTS in Karuni Village

Karuni Village, located in Southwest Sumba Regency, East Nusa Tenggara, Indonesia, is one of Indonesia's many remote areas that lack access to the primary power grid. Off-grid PLTS has been implemented as an electricity solution in this village to address this limitation, as shown in Figure 1.



Figure 1. Location of 6.5 kWp off-grid PLTS

The power output generated by the PLTS is then distributed to households and loads such as street lighting (PJU). The household load uses an energy limiter to limit the power supply to 400 W. The distribution mapping of the electricity generated by the PLTS to the community, consisting of 32 houses, including two schools and one church, is shown in Figure 2 below.

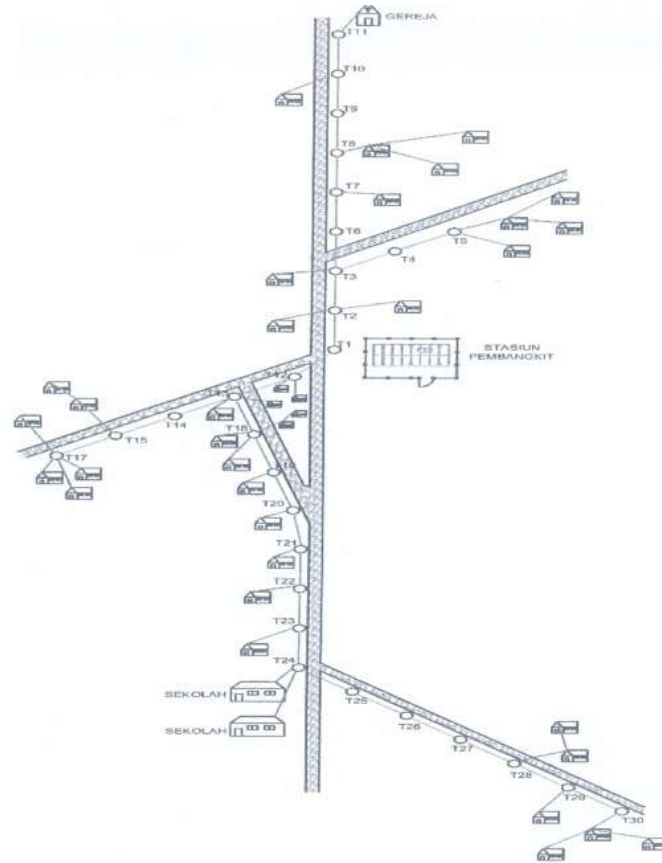

Figure 2: Map of PLTS electricity distribution in Karuni Village

Off-Grid Solar Power Systems (PLTS) in Karuni Village generally consist of several main components as depicted in Figure 3, including:

1. Solar Panels: The CHSM72M-HC 410 model is used, a product of ASTRO 3 with monocrystalline technology and a capacity of 410 Wp per panel. The total number of panels used is 16 panels arranged in 2 arrays. Each array consists of 4 strings, with each string comprising two panels connected in series.
2. Batteries: The SUPBLP-512100 model, a PT product, is used. Surya Utama Putra. These batteries have a capacity of 51.2 kWh, and six are used. Each battery is connected in parallel.
3. Solar Charger Controller (SCC): The VarioTrack VT 65 model is used, a product of Studer. The number of SCCs used in this system is two units with a capacity of 4 kW each. Each SCC is connected to both solar panel arrays.
4. Inverter: Responsible for converting the DC electrical energy generated by the solar panels into AC electrical energy using the Xtender XTM 6000-48 model, a product of Studer. The number of inverters used in this system is two units with a capacity of 5 kW each.

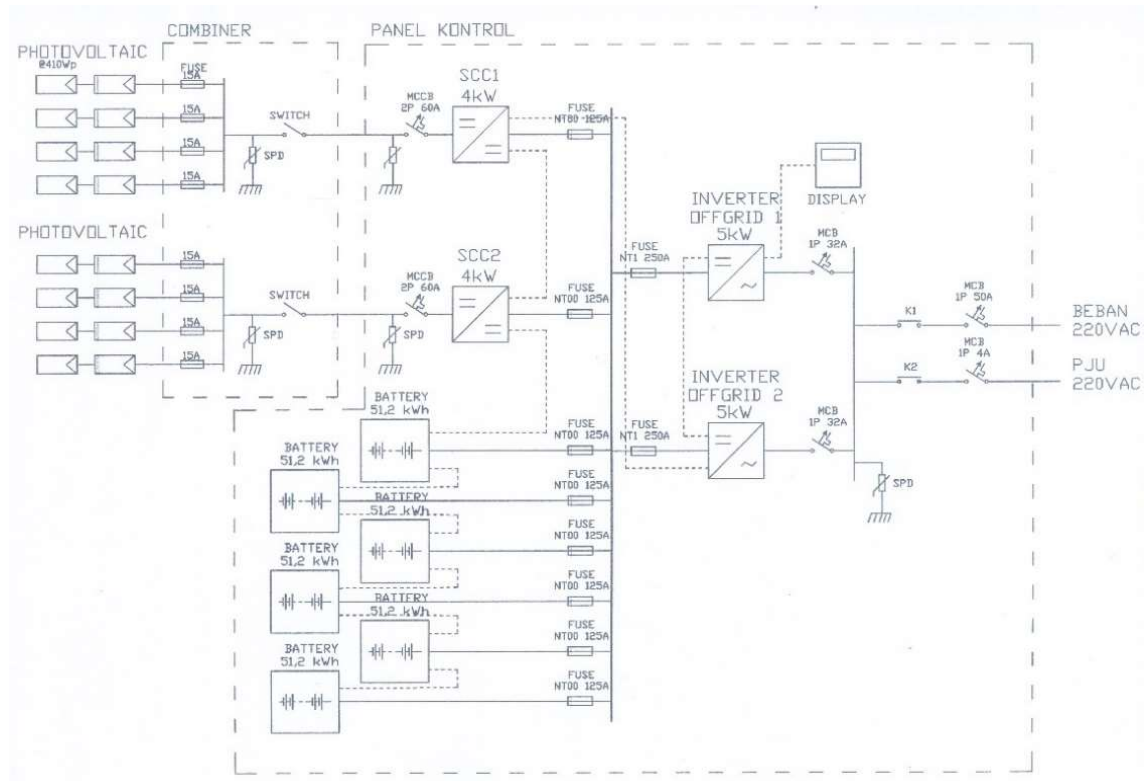

Figure 3: Single line diagram of 6.5 kWp Karuni Village PLTS

4.2 Input Parameters in PVSyst Simulation

PVSyst is a simulation software that requires a number of input parameters to plan and analyze PV systems. These input parameters include information about the geographical location, physical and technical configuration of the PV system, and characteristics of main components such as solar panels, batteries, SCC, and inverters.

1. Geographic Location For accurate simulation, information about the geographical location is crucial. This includes geographic coordinates, encompassing latitude and longitude, of the PV system location. Based on the location of the Karuni Village PV system, the coordinates are latitude -9.449393358395463 and longitude 119.292383947244. These coordinates serve as input parameters to determine historical weather data such as daily solar irradiation, temperature, and air humidity needed for simulation purposes as shown in Figure 4. This data assists PVSyst in calculating the solar radiation received by a specific location, which significantly affects the performance of the PV system. After setting the geographic location, the system automatically provides environmental conditions according to the set coordinates as shown in Figure 5. This environmental data is sourced from Meteonorm 8.1 for the years 2016-2021.

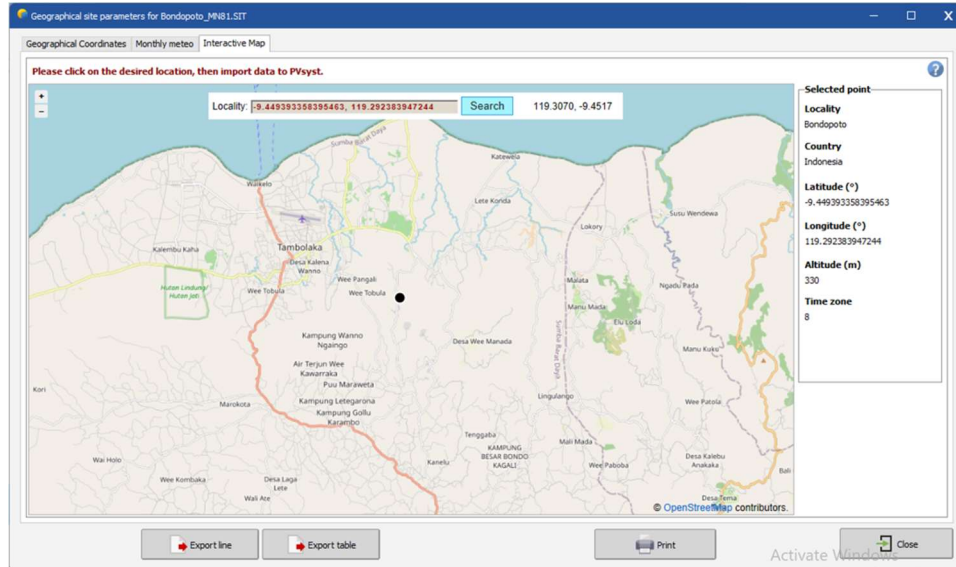

Figure 4: Display of location input parameters

Monthly Meteo Values

Source: Meteornorm 8.1 (2016-2021), Sat=100%

	Jan.	Feb.	Mar.	Apr.	May	June	July	Aug.	Sep.	Oct.	Nov.	Dec.	Year
Horizontal global	171.9	146.7	162.8	171.7	158.5	146.0	164.4	176.2	180.7	211.1	191.9	179.7	2061.6 kWh/m ²
Horizontal diffuse	76.4	84.4	73.5	64.3	59.9	50.9	51.0	60.3	69.8	75.2	73.8	76.9	816.4 kWh/m ²
Extraterrestrial	339.1	304.6	324.9	288.7	269.7	245.2	258.6	282.5	301.2	330.4	326.3	337.6	3608.8 kWh/m ²
Clearness Index	0.507	0.482	0.501	0.595	0.588	0.595	0.636	0.624	0.600	0.639	0.588	0.532	0.571 ratio
Ambient Temper.	26.0	25.8	25.9	25.8	25.7	24.4	24.3	24.5	25.3	26.9	26.8	26.5	25.6 °C
Wind Velocity	1.5	1.5	1.6	1.8	1.9	2.2	2.4	2.6	2.5	2.4	1.9	1.6	2.0 m/s

Figure 5: Display of environmental conditions provided by PVSyst.

2. PLTS System Configuration The configuration of the PV system is also an important input parameter in PVSyst simulation. This includes the orientation and tilt angle of the solar panels. The orientation and tilt angle of the solar panels are adjusted according to the field conditions of the PV system where the Tilt Angle is 13° and Azimuth is 0°. Then, the selected field type is "Fixed Tilted Plane" because the orientation of the PV system is static. The settings of these input parameters can be seen in Figure 6. In addition to the orientation and tilt of the panels, adjustments are also made to the number of panels and strings as shown in Figure 7.

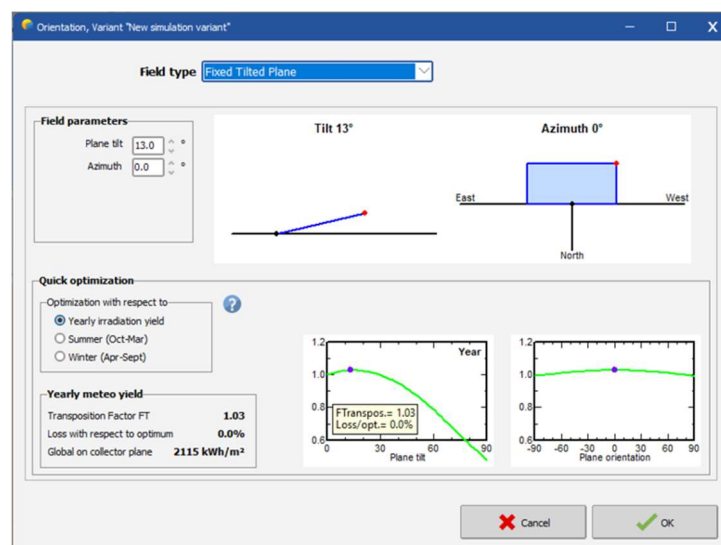

Figure 6: Display of settings in system configuration

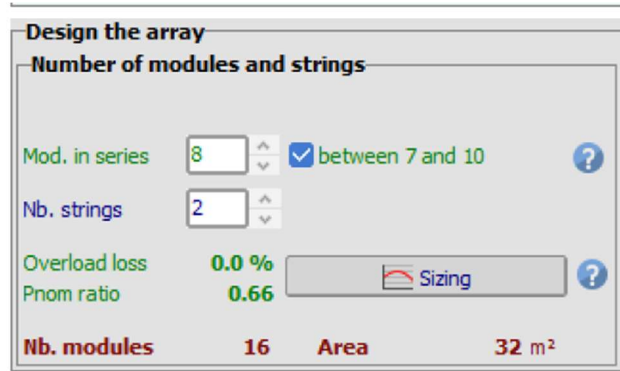

Figure 7: Display of settings in array design

3. Characteristics of Main Components

The efficiency and capacity of main components such as solar panels, batteries, charge controller, and inverter are also crucial factors in PVSyst simulation. The efficiency of solar panels, battery capacity and lifecycle, as well as the efficiency of battery charge controller and inverter, are essential information. This data helps in estimating how much energy the system can generate and how the system will operate under real conditions. The data to be input is adjusted to the technical specifications of each component used in the Karuni Village PV system. For each input parameter setting on the main components consisting of solar panels, SCC, battery, and inverter, can be seen in Figure 8, 9, 10.

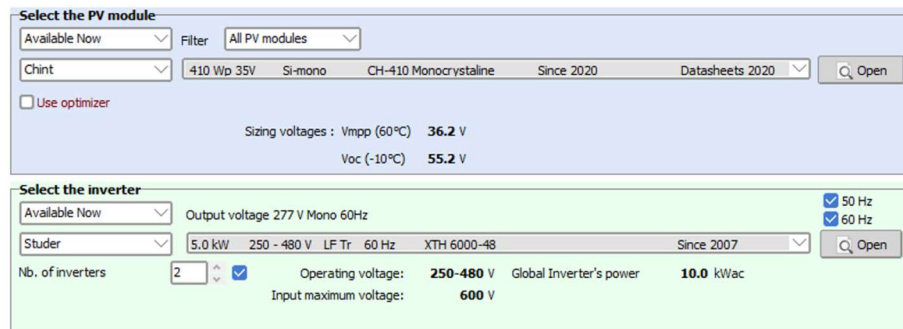

Figure 8: Display of settings for Solar Panels and Inverter

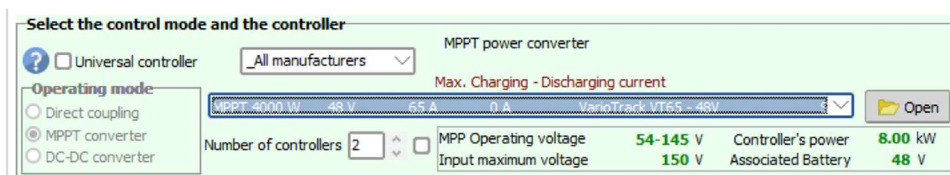

Figure 9: Display of settings for SCC

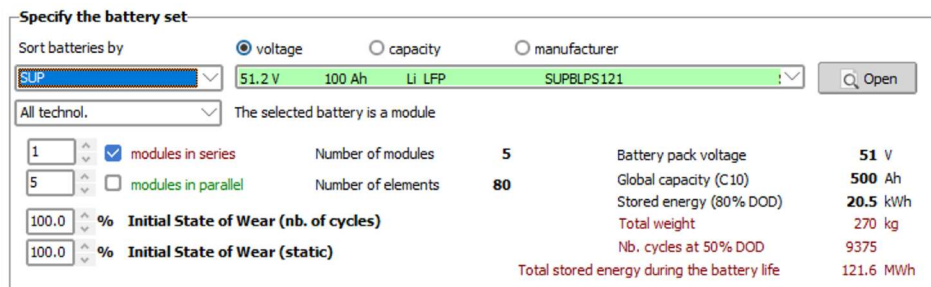

Figure 10: Display of settings for Batteries

4.3 Comparison of Actual Results and PVSyst Simulation

Actual energy production data from the off-grid PLTS in Karuni Village is obtained through the PLTS system monitoring database. This data includes daily monthly, and annual energy production from the installed PLTS system. Meanwhile, the simulation results of the PLTS are generated using the PVSyst software, utilizing parameters corresponding to the physical and technical configuration of the installed PLTS. By comparing actual data and simulation results, the accuracy and effectiveness of the PVSyst software in predicting the performance of the Off-Grid PLTS in Karuni Village will be evaluated.

4.3.1 Actual Data and PLTS Simulation in Karuni Village 6.5 kWp

The data used in this study consists of the total energy production each month and the daily average irradiance values. The data covers the time range from January 1, 2022, to December 31, 2022. Table 1 presents the actual and simulated energy production data and solar irradiance values in the PLTS.

Table 1. PLTS Energy Production Data and Daily Average Irradiance

Month	Daily Average POA Irradiance (kWh/m ² /day)		Energy Production (kWh)	
	Simulation	Actual	Simulation	Actual
	January	5.15	4.70	815.42
February	5.06	5.26	730.28	711.90
March	5.29	5.21	840.92	780.02
April	6.25	5.67	939.82	825.55
Mey	5.63	5.71	910.33	871.25
June	5.48	5.44	864.39	813.83
July	6.34	5.84	966.03	902.32
Agust	6.14	6.20	999.94	943.92
September	6.19	6.63	966.43	965.75
October	6.67	6.27	1067.90	933.32
November	5.98	4.37	920.00	618.53
December	5.50	4.72	840.57	701.62
Average	5.81	5.5	949.94	854.69

Based on Table 1 data, the effective sunlight exposure duration in the area can be calculated using the following equation:

$$Sun\ Hour = \frac{Daily\ Average\ POA\ Irradiance}{G_{STC}} \quad (5)$$

Where:

Sun Hour: Effective sunlight exposure duration (Hours)

Daily Average POA Irradiance: Irradiance on the array plane (kWh/m²/day)

G_{STC}: Reference irradiance STC (1 kW/m²/day)

From equation (5), the effective sunlight exposure duration for 1 day on the PV system can be determined. For the average effective sunlight exposure duration from the PVSyst simulation results as follows:

$$Sun\ Hour = \frac{5810\ kWh/m^2/day}{1000\ kW/m^2/day}$$

$$Sun\ Hour = 5.81\ hours$$

Using equation (5), we can also determine the average effective sunlight exposure duration for 1 day as follows:

$$\text{Sun Hour} = \frac{5500 \text{ kWh/m}^2/\text{day}}{1000 \text{ kW/m}^2/\text{day}}$$

$$\text{Sun Hour} = 5.5 \text{ hours}$$

Therefore, based on the calculation using equation (5), the average effective sunlight exposure duration at the PV system in Karuni Village is 5.81 hours based on simulation results and 5.5 hours based on actual results.

4.3.2 PLTS Performance Results

To evaluate the performance of the PLTS, actual and simulated data were analyzed based on the IEC 61724 standard. The analysis included calculations of the Final System Yield (Y_F) and Reference Yield (Y_R) using equations (1) and (2). Furthermore, calculations were performed for the Performance Ratio (PR) and Capacity Utilization Factor (CUF) using equations (3) and (4). Table 2 shows the performance calculation results of the PLTS under the two applied conditions.

Table 2. Performance of 6.56 kWp Karuni Village PLTS Based on Actual and Simulation Data

Month	Y_F		Y_R		PR		CUF	
	Simulation	Actual	Simulation	Actual	Simulation	Actual	Simulation	Actual
January	124.30	108.38	159.62	145.64	77.87%	74.42%	16.71%	14.57%
February	111.32	108.52	141.70	147.20	78.56%	73.73%	16.57%	16.15%
March	128.19	118.91	163.84	161.51	78.24%	73.62%	17.23%	15.98%
April	143.27	125.85	181.12	164.52	79.10%	76.49%	20.58%	18.08%
Mey	138.77	132.81	174.53	176.98	79.51%	75.04%	18.65%	17.85%
June	131.77	124.06	164.47	163.20	80.12%	76.02%	18.30%	17.23%
July	147.26	137.55	183.79	169.42	80.12%	81.19%	21.16%	19.76%
Agust	152.43	143.89	190.41	192.26	80.05%	74.84%	20.49%	19.34%
September	147.32	147.22	185.74	198.78	79.32%	74.06%	20.46%	20.45%
October	162.79	142.27	206.63	194.31	78.78%	73.22%	21.88%	19.12%
November	140.24	94.29	179.43	131.22	78.16%	71.86%	19.48%	13.10%
December	128.14	106.95	164.93	141.54	77.69%	75.56%	17.80%	14.85%
Average	137.98	124.22	174.68	165.55	78.96%	75.00%	19.11%	17.21%

4.3.3 Discussion

Calculations were conducted to determine the difference between actual and simulated values based on the analysis of the performance of the 6.5 kWp Off-Grid PLTS system in Karuni Village. These calculations indicate the extent of the difference between actual and simulated values, providing insight into the factors contributing to the discrepancies in results. The differences in each value can be observed in the following Table 3.

Table 3. Difference Comparison of PLTS Analysis Results in Karuni Village 6.56 kWp Against Actual and Simulation Data

Month	Y_F	Y_R	PR	CUF	Energy Production
January	15.92	13.98	3.45%	2.14%	13%
February	2.80	5.50	4.83%	0.42%	3%
March	9.28	2.33	4.62%	1.25%	8%
April	17.42	16.60	2.61%	2.50%	12%

Month	Y _F	Y _R	PR	CUF	Energy Production
Mey	5.96	2.45	4.47%	0.80%	4%
June	7.71	1.27	4.10%	1.07%	6%
July	9.71	14.37	1.07%	1.40%	6%
Agust	8.54	1.85	5.21%	1.15%	5%
September	0.10	13.04	5.26%	0.01%	0%
October	20.52	12.32	5.56%	2.76%	12%
November	45.95	48.21	6.30%	6.38%	33%
December	21.19	23.39	2.13%	2.95%	17%
Average	13.76	12.94	4.13%	1.90%	10%

From Table 3, in the energy production section, there is a significant difference of about 10% between the actual results and the simulation results. Several factors may contribute to this difference, including:

1. **Local Weather Conditions:** Weather factors such as sunlight intensity, air temperature, and humidity can vary over time. These differences can significantly affect the performance of the solar photovoltaic (PV) system, especially in terms of energy production from solar panels. The local weather condition data provided by the PVSyst application ranges from 2016 to 2021, while the actual data occurred in 2022. This could introduce variations in environmental factors that are not exactly the same between simulation and actual conditions.
2. **Maintenance and System Management:** The performance of the solar PV system can also be influenced by the level of maintenance and system management carried out by the operator. For example, the cleanliness of solar panels, battery conditions, and inverter settings can affect system performance. In contrast, the simulation did not consider losses caused by environmental factors or electrical losses on components. This will also cause a difference in the difference between the simulation results and the actual results, where the simulation results tend to be higher than the actual results.
3. **Limitations of Simulation Models:** Although the PVSyst software has sophisticated mathematical models to simulate the performance of solar PV systems, there are limitations in these models that can lead to differences from real-world conditions. For example, simulation models may not accurately account for factors such as real-time weather changes.

The disparity between actual and simulated results offers valuable insights into the accuracy of PVSyst for solar PV system planning. Evaluating the impact of these factors can inform recommendations for improving simulation accuracy. By addressing these factors, such as refining simulation models or incorporating more accurate data, we can enhance the precision of solar PV system planning and management. Additionally, exploring alternative simulation applications may provide further insights and improvements in accuracy.

5. CONCLUSION

In this study, a comparison has been made between the actual energy production results from Off-Grid Solar Photovoltaic (PV) Systems in Karuni Village, Southwest Sumba, and the simulation results obtained through the PVSyst software. The analysis results indicate a significant difference, reaching approximately 10%, between the actual and simulated results. Several factors have been identified as the causes of this difference.

The first factor is local weather conditions, where variations in sunlight intensity, air temperature, and humidity can significantly affect the performance of the PV system. Additionally, differences in the level of maintenance and system management can also affect the performance of the PV system. This includes the cleanliness of solar panels, battery conditions, and inverter settings, which are not always accurately accounted for in simulations. Finally, limitations in the PVSyst simulation model can also lead to differences between actual and simulated results.

The implications of these findings highlight the importance of using more accurate data in simulations, improving the maintenance of PV systems, and developing more sophisticated simulation models. Recommendations for further research include further analysis to understand the factors

influencing the difference between actual and simulated results and attempting analysis using other similar applications. By understanding the factors affecting this difference, areas where simulation models need to be improved or enhanced can be identified.

Overall, this study provides valuable insights into the planning and management of Off-Grid PV systems in remote areas. Efforts to improve the accuracy of planning and managing PV system in the future will be key to ensuring reliable and sustainable electricity supply for communities in remote areas such as Karuni Village, Sumba.

REFERENCE

- [1] N. Winanti and A. Purwadi, "Study and Design of Distributed Hybrid PV-Generator-Battery System for Communal and Administrative Loadat Sei Bening Village, Sajingan Besar, Indonesia," in *2018 2nd International Conference on Green Energy and Applications (ICGEA)*, Singapore: IEEE, Mar. 2018, pp. 129–133. doi: 10.1109/ICGEA.2018.8356300.
- [2] F. B. Setiawan, S. Riyadi, L. H. Pratomo, and A. Wibisono, "A 5.4 kWp Microgrid Laboratory Development for Higher Education and Industrial Workshop," in *2022 14th International Conference on Software, Knowledge, Information Management and Applications (SKIMA)*, Phnom Penh, Cambodia: IEEE, Dec. 2022, pp. 89–94. doi: 10.1109/SKIMA57145.2022.10029640.
- [3] N. Winanti, B. Halimi, A. Purwadi, and N. Heryana, "Study and Design of Energy-Saving Solar Lamp for Rural Area in Indonesia," in *2018 2nd International Conference on Green Energy and Applications (ICGEA)*, Singapore: IEEE, Mar. 2018, pp. 98–102. doi: 10.1109/ICGEA.2018.8356307.
- [4] N. Winanti, A. Purwadi, B. Halimi, and N. Heryana, "Study and Design of Energy-Saving Solar Lamp for Small Island in Indonesia : Matakus Island," in *2018 Conference on Power Engineering and Renewable Energy (ICPERE)*, Solo, Indonesia: IEEE, Oct. 2018, pp. 1–5. doi: 10.1109/ICPERE.2018.8739672.
- [5] A. K. Singh, K. Pal, and N. K. Gupta, "Performance Evaluation of a 4 kW Isolated Solar Powered Lab with IoT Energy Management System," in *2019 2nd International Conference on Power Energy, Environment and Intelligent Control (PEEIC)*, Greater Noida, India: IEEE, Oct. 2019, pp. 418–423. doi: 10.1109/PEEIC47157.2019.8976598.
- [6] S. F. A. Shah, I. A. Khan, and H. A. Khan, "Performance Evaluation of Two Similar 100MW Solar PV Plants Located in Environmentally Homogeneous Conditions," *IEEE Access*, vol. 7, pp. 161697–161707, 2019, doi: 10.1109/ACCESS.2019.2951688.
- [7] K. S. N. Abhishek et al., "Analysis of Software Tools for Renewable Energy Systems," in *2018 Internat2018 International Conference on Computation of Power, Energy, Information and Communication (ICCPEIC)ional conference on computation of power, energy, Information and Communication (ICCPEIC)*, Chennai, India: IEEE, Mar. 2018, pp. 179–185. doi: 10.1109/ICCPEIC.2018.8525160.
- [8] S. Kumar, P. Upadhyaya, and A. Kumar, "Performance Analysis of Solar Energy Harnessing System Using Homer Energy Software and PV Syst Software," in *2019 2nd International Conference on Power Energy, Environment and Intelligent Control (PEEIC)*, Greater Noida, India: IEEE, Oct. 2019, pp. 156–159. doi: 10.1109/PEEIC47157.2019.8976665.